

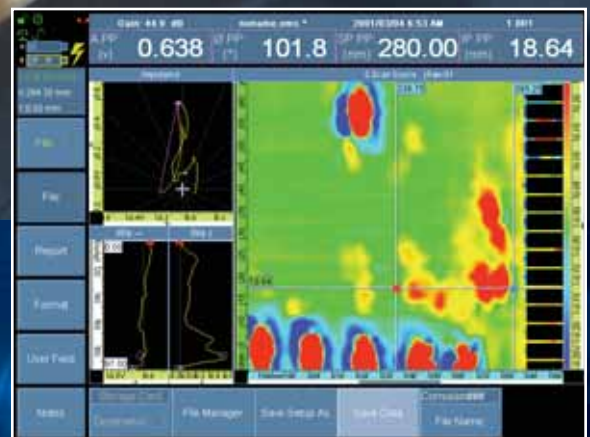

# omniScan™

ULTRASOUND, UT PHASED ARRAY, EDDY CURRENT, AND EC ARRAY



- Portability
- Modularity
- Color imaging
- Data storage

See it all!



# OmniScan™ MX

OmniScan™ is the newest family of modular and portable test units from R/D Tech. This family includes the innovative phased array and eddy current array test units, as well as the newly introduced eddy current and conventional ultrasound modules, all designed to meet the most demanding requirements of NDT. The OmniScan offers a high acquisition rate and powerful software features in a portable, modular mainframe to efficiently perform manual and automated inspections.

## Rugged, Portable, and Battery-Operated

The OmniScan™ is built to work in the harshest field conditions. Its solid polycarbonate-based casing and rubber bumpers make it a rugged instrument that can withstand drops and shocks.

The OmniScan is so compact and lightweight (only 4.6 kg) that it can be carried easily and handled anywhere inside or outside. The OmniScan will run 6 hours with its two Li-ion batteries.

## User Interface

The highly legible 8.4-inch real-time display (60-Hz A-scan refresh rate) with a SVGA resolution of 800 x 600 allows you to clearly see defects and details under any light conditions. A scroll knob and function keys make it easy to browse through and select functions. A mouse and a keyboard can also be plugged in for users looking for a more PC-like interface.

## Modular Platform

The instrument is a modular platform that allows you to switch among its different test modules on location. The platform detects the new module and the technology supported so that the configuration and test environment are set automatically.

## OmniScan Connector

The OmniScan connector has a probe ID feature that enables physical detection and recognition of the probe connected to the mainframe.

- Sets the probe to an appropriate frequency to prevent probe damage.
- Sets C-scan resolution of ECA probes.
- Loads the correct probe parameters.

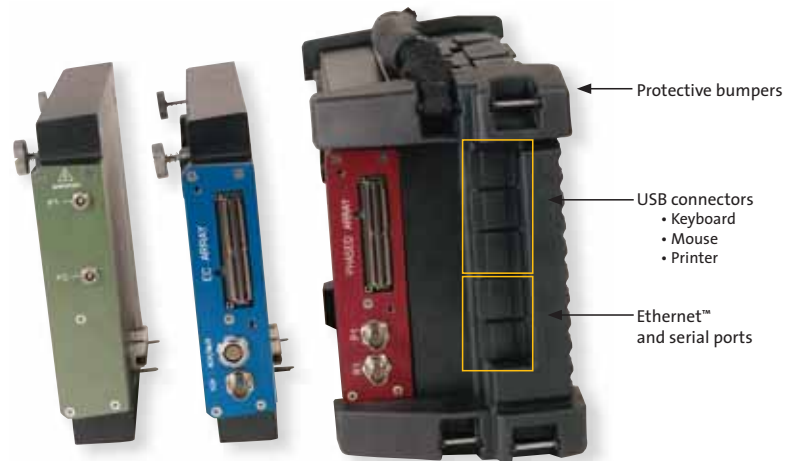
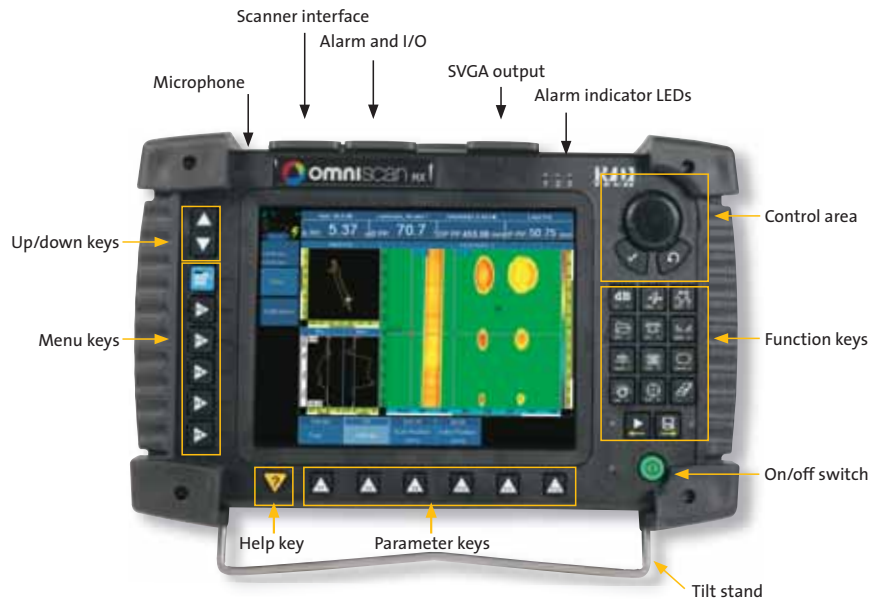

UT module

Eddy current array module

Phased array module



## Storage and Report

- Setup storage compatible with Microsoft® Windows® (exportable using a CompactFlash® card)
- Complete report setup including reading configuration, which can be customized using HTML page layout
- On-screen interactive help that can be customized for procedure-oriented setups using HTML script templates
- Setup preview

## Connectivity, Data Storage, and Imaging

The OmniScan™ offers alarm outputs as well as the standard PC ports: USB, RS-232, SVGA out, and Ethernet™. It offers internal data storage capability and extended storage via a CF (CompactFlash®) card slot or USB device.



## Typical Applications

### Girth Weld Inspection

R/D Tech has developed a circumferential weld inspection system based on the OmniScan PA for the oil and gas industry. This phased array system is qualified to inspect tube with diameters ranging from 48 mm to 1524 mm and thicknesses from 5 mm to 25 mm in compliance with ASME Boiler and Pressure Vessel Code Section V. The semiautomated system offers better inspection speed and detection, and makes the interpretation of the indications significantly easier.



### Inspection of Tee-Joint Welds on Bridge Structures

Automated welding used to build multiple parts of bridge structures can generate cracks in the upper part of the weld of thin stiffeners. The OmniScan allows simultaneous scanning from 40 to 70 degrees. Users can inspect the complete volume of the weld in a single pass. Compared to conventional UT, this technique enables an inspector, with a few hours of training, to operate at least five times faster and present more reliable results.



### Landing Gear Inspection

The OmniScan allows the complete inspection of a critical section of the landing gear: a cylinder possessing three different diameters in the zone of interest. The inspection is done in a single pass with 40- to 65-degree shear wave refracted angles in the part. With this system, any inspector can perform the inspection faster, and with better reliability.



### Aircraft Fuselage Inspection

The OmniScan ECA provides the ability to detect hidden corrosion in multilayer structures and especially in lap joints independently of lack of sealant. Currently, material loss of 10% of the lap splice thickness can be detected in aluminum at a depth of 0.2 inch. Surface and subsurface cracks can be detected in the skin, at the fastener, or at the lap joint edges.



# Ultrasound Inspection

## 0-Degree Testing

### (Immersion, Corrosion, Composite)

The 0-degree testing measures time-of-flight and amplitude of ultrasonic echoes reflecting from the part into gates to detect and measure defects.

- C-scan imaging
- Full A-scan recording with C-scan post-processing

## Angle Beam Testing

Angle beam testing enables the detection of vertical or thin defects that 0-degree inspection might miss because of poor sound reflection. Angle beam testing uses an angled wedge to create the desired angle.

- True depth configuration
- Flaw sizing using tip diffraction technique
- Raster scans (A, B, C, and D scans)
- Built-in FFT for probe characterization

## Time-of-Flight Diffraction (TOFD) Testing

TOFD is a technique that uses two probes in pitch-and-catch mode. TOFD detects and records signals diffracted from defect tips for both detection and sizing. The TOFD data is displayed in a grayscale B-scan. TOFD offers wide coverage and amplitude-independent sizing compliant with ASME-2235 code.

- One-line scan for full-volume inspection
- Setup independent of weld configuration
- Very sensitive to all kinds of defects and insensitive to defect orientation

## Ultrasound Transducers

R/D Tech offers thousands of transducers in standard frequencies, element diameters, and connector styles.

- Contact and immersion transducers
- Dual transducers
- Angle beam transducers and wedges
- Replaceable delay line transducers
- Protected-face transducers
- Normal incidence shear wave transducers

## TOFD Caliper

The TOFD caliper is small, lightweight, easily portable, and simple to use on a variety of different inspections. The probe distances are easily adjusted, and angles can be set to 45°, 60°, and 70°. The TOFD caliper opens up new possibilities for fast manual inspection with permanent record of the results.

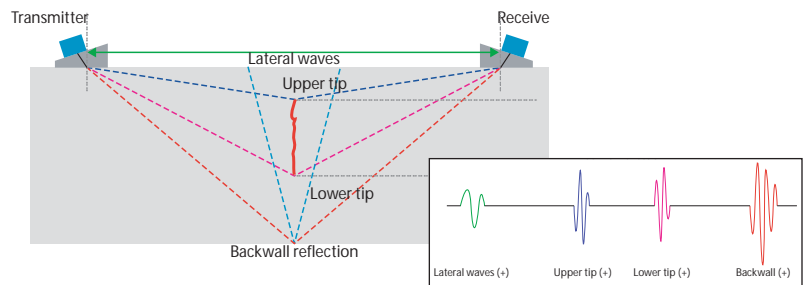
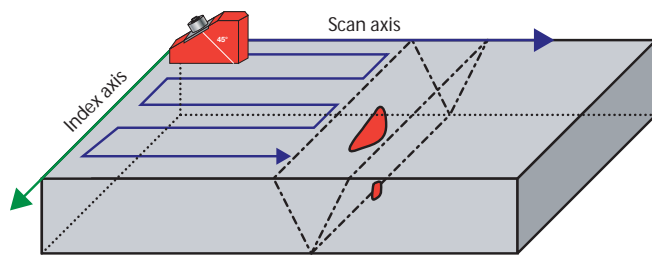
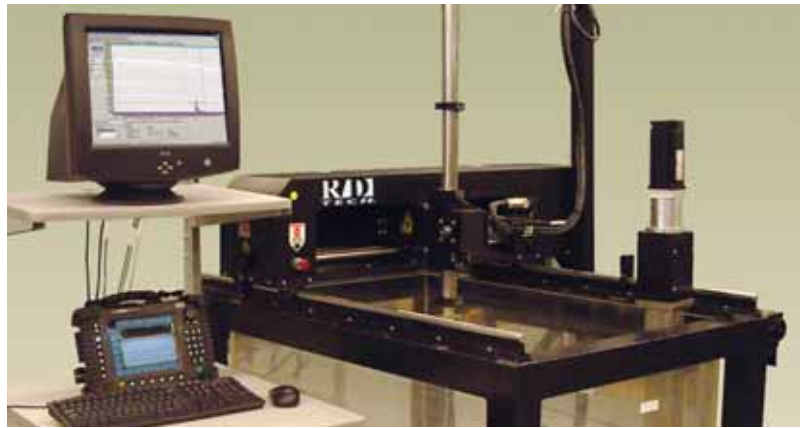

General view of TOFD setup for linear weld inspection showing lateral wave, backwall echo, and diffracted signals on the A-scan.



# Ultrasound Software

## Full-Featured C-Scan

- Monitoring of amplitude, peak position, crossing level position, and thickness on each gate
- Automatic gate synchronizes from previous gate for higher dynamic range of thickness.
- A-scan data storage and C-scan postprocessing capabilities

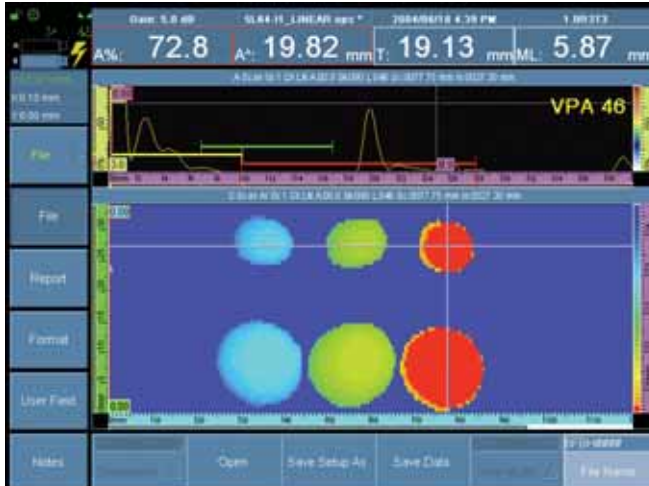

- Optional IF gate for surface following synchronization or measurement gate or TCG/DAC curves
- Either positive or negative gate on RF signal (independent for each gate)
- Three alarms completely configurable on single gate events or multiple gate events, filter for  $n$  occurrences from one or multiple channels
- Customizable color palette for amplitude and thickness C-scan
- 2-axis mechanical encoder with data acquisition synchronization on mechanical movement
- Optional data library to access A-scan and/or C-scan on PC for custom processing
- 60 Hz A-scan refresh rate with overlays of envelope and peak inside the gate

## Angle Beam Transducer for Weld Inspection

- Trigonometric flaw location with curvature correction for angle beam transducer
- Optional DAC and TCG curves for compensation of material attenuation as well as beam spread
- Assisted calibration for probe delay and sound velocity, as well as TCG and mechanical encoder
- Support of pulse-echo, dual, or through-transmission modes
- Visual skip indicator for easy location of the defect

## Full-Featured A-Scan

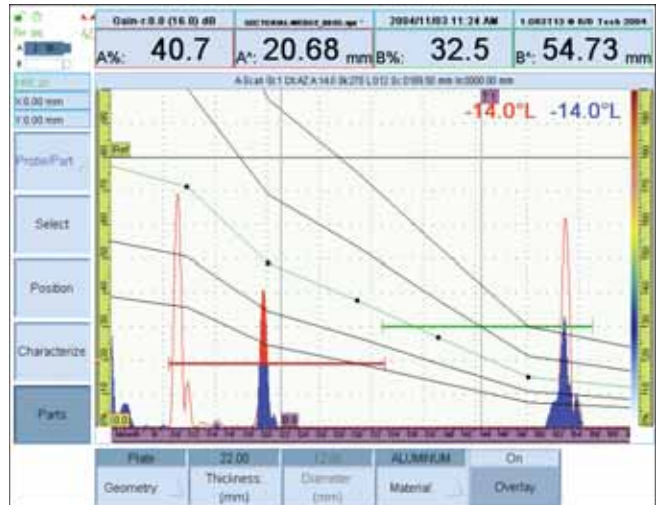

Indoor/outdoor color schemes for improved readability in all conditions.

- Color-selectable A-scan display
- Reject mode
- Hollow mode
- Peak/hold mode (always keep the signal that shows the maximum amplitude in gate A)
- Gate threshold level crossing (changes the color of the curve that is over the gate level)

## TOFD

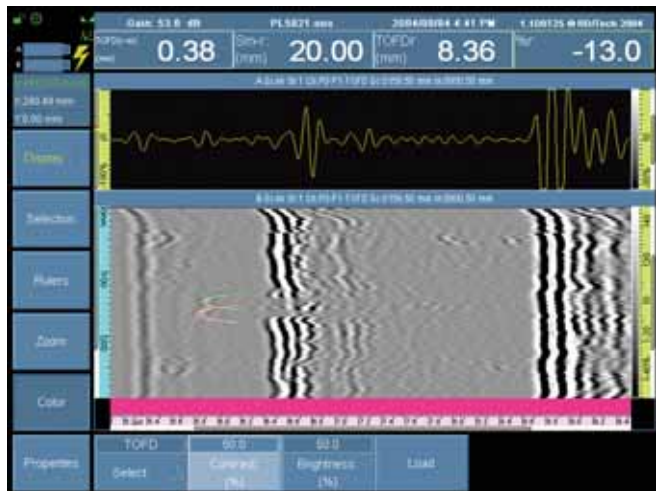

- A B-scan encoded data imaging and storage
- Adjustable for brightness and contrast grayscale color palette
- 100 MHz A-scan digitizing
- TOFD calibration wizard online and offline
- Hyperbolic cursor and reading for TOFD sizing
- Lateral wave resynchronization

# Phased Array Inspection

## Phased Array Technology

Phased array technology generates an ultrasonic beam with the capability of setting beam parameters such as angle, focal distance, and focal point size through software. Furthermore, this beam can be multiplexed over a large array. These capabilities open a series of new possibilities. For instance, it is possible to quickly vary the angle of the beam to scan a part without moving the probe itself. Phased arrays also allow the replacement of multiple probes and even mechanical components. Inspecting a part with a variable-angle beam also maximizes detection regardless of the defect orientation, while optimizing signal-to-noise ratio.

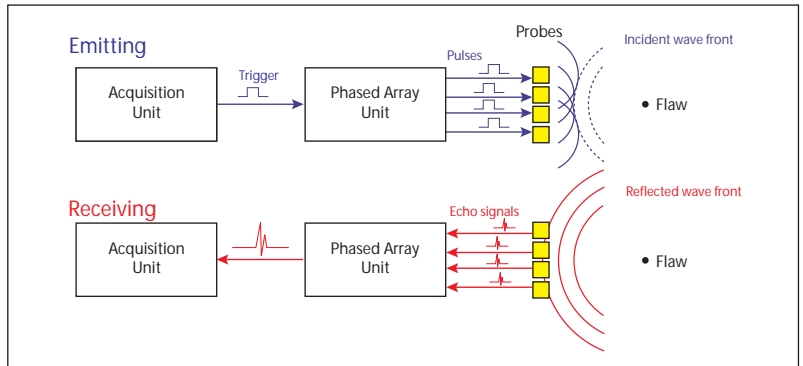

To generate a beam, the various probe elements are pulsed at slightly different times. By precisely controlling the delays between the probe elements, beams of various angles, focal distances, and focal spot sizes can be produced. The echo from the desired focal point hits the various transducer elements with a computable time shift. The signals received at each transducer element are time-shifted before being summed together.

## Benefits of Phased Arrays

Phased array technology offers the following capabilities:

- Software control of beam angle, focal distance, and spot size
- Multiple-angle inspection with a single, small, electronically controlled, multielement probe
- Greater flexibility for the inspection of complex geometry
- High-speed scans with no moving parts

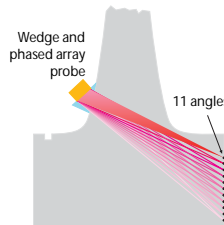

Multiple-angle inspection with one multielement probe.

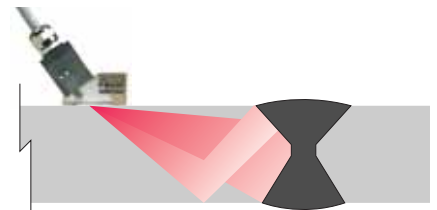

Greater flexibility for the inspection of complex geometry.

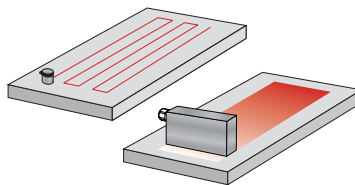

The use of phased array probes can eliminate one axis of a two-axis scan.

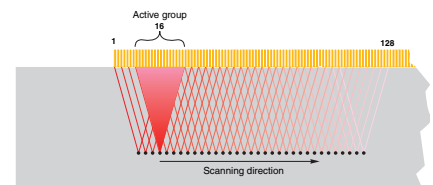

High-speed scans with no moving parts. Compared to a wide, single-element transducer, phased array technology offers a much higher sensitivity due to the use of a small focused beam.

## Phased Array Probes

R/D Tech's standard phased array transducers are divided in four types:

- Angle beam transducers with external wedges (1) (2)
- Angle beam transducers with internal wedges (3)
- Contact transducers (4)
- Immersion transducers (5)

Water boxes for immersion transducers are also available (6), as are numerous accessories, such as encoders (7).

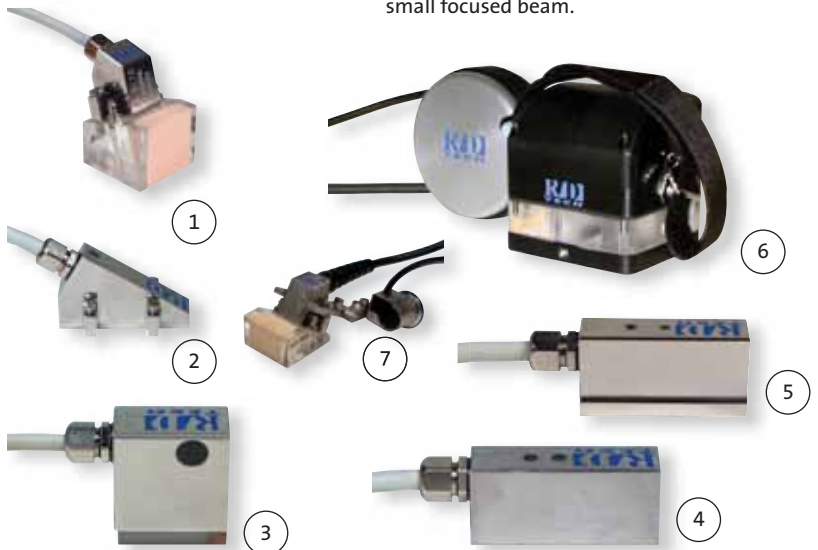

# Phased Array Software

## Full-Featured A-Scan

- User-selectable A-scan color
- Reject mode
- Hollow and filled display mode
- Fast 60 Hz refresh rate for analog-like display

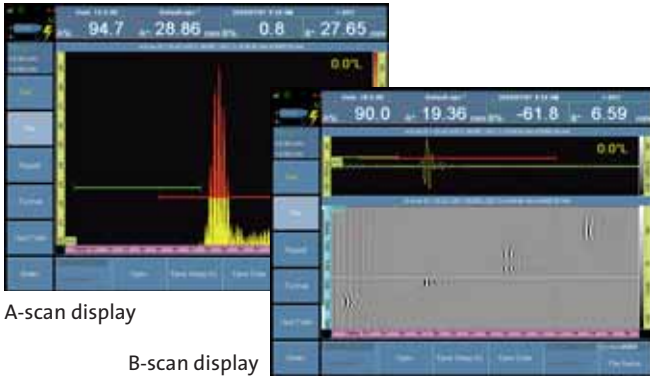

A-scan display

B-scan display

## Full-Featured B-Scan

- Easy-to-interpret cross-sectional view of inspected part
- Excellent presentation for corrosion mapping of pipes, boilers, and storage tanks
- Allows the operator to visually verify acquired thickness points as well as zoom in on areas with critically thin thickness values.
- Encoded TOFD capability for amplitude-independent defect sizing

## Full-Featured C-Scan

- Adjustable 256-level color palette
- Encoded C-scan storage and imaging capabilities
- Dual gate amplitude and measurement C-scan
- Built-in measurement and analysis tools



C-scan display on OmniScan PA.

## Full-Featured Sectorial Scan

- Real-time volume-corrected representation
- Higher than 20 Hz refresh rate (up to 40 Hz)

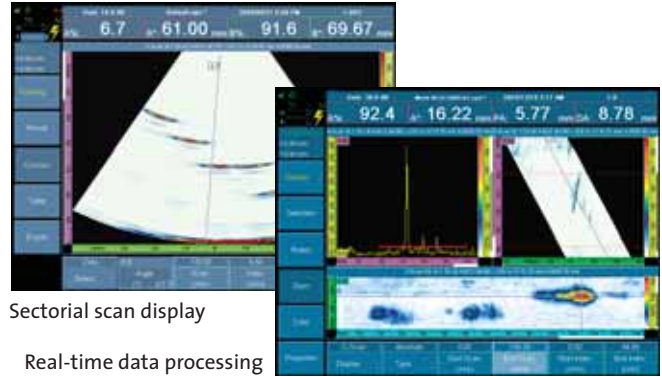

Sectorial scan display

Real-time data processing

## Advanced Real-Time Data Processing

- Real-time data interpolation to improve spatial representation of defects during acquisition of data
- User-selectable high- and low-pass filters to enhance A-scan and imaging quality
- Projection feature allows the operator to view vertically positioned A-scan simultaneously with sectorial scan image.

## PC-Based Analysis Software: TomoView™

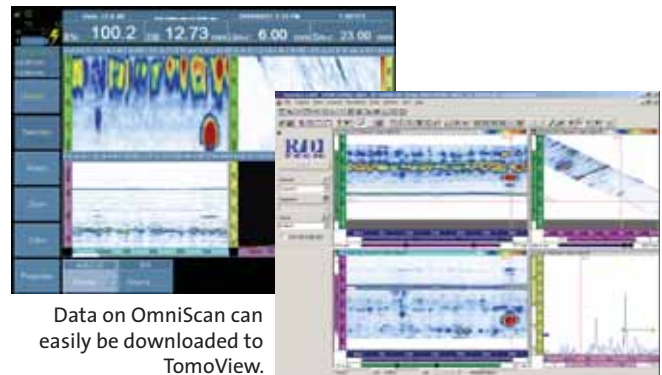

Data on OmniScan can easily be downloaded to TomoView.

- OmniScan™ data is compatible with R/D Tech's TomoView™ PC-based software platform.
- Offline analysis A, B, C, D, and sectorial scans (S-scan)
- Measurement utilities, zooming, and customizable color palette
- Compatible with advanced focal law calculator

# Eddy Current Inspection

## Eddy Current Technology

Eddy current (ECT) technology is a noncontact method for the inspection of metallic parts. In this technique, the probe, which is excited with an alternative current, induces eddy current in the part under inspection. Any discontinuities or material property variations that change the eddy current flow in the part are detected by the probe as a potential defect.

Over the years, probe technology and data processing have continuously progressed so that the eddy current technique is now recognized to be fast, simple, and accurate. This is why the technique is widely used in the aerospace, automotive, petrochemical, and power generation industries for the detection of surface or near-surface defects in material such as aluminum, stainless steel, copper, titanium, brass, Inconel®, and even carbon steel (surface defect only).

### Benefits of Eddy Current

Eddy current offers the following capabilities:

- Quick, simple, and reliable inspection technique to detect surface and near-surface defects on conductive material
- Can be used to measure material electrical conductivity.
- Measurement of nonconductive coating
- Hole inspection with the use of high-speed rotating scanner and surface probe

### Eddy Current Probes

R/D Tech's standard eddy current probes are available in different configurations:

- Bolt hole probes
- Surface probes, in various shapes and configurations
- Low-frequency Spot and Ring type probes
- Sliding probes
- Wheel probes
- Conductivity probes
- Speciality probes made for specific applications

Reference standards with EDM notches can be manufactured according to the application specifications.

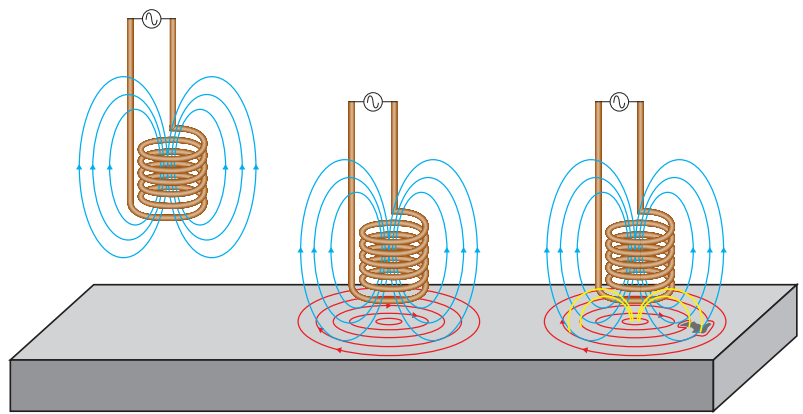

Probes used to perform eddy current inspections are made with a copper wire wound to form a coil. The coil shape can vary to better suit specific applications.

- The alternative current flowing through the coil at a chosen frequency generates a magnetic field around the coil.
- When the coil is placed close to an electrically conductive material, eddy current is induced in the material.
- If a flaw in the conductive material disturbs the eddy current circulation, the magnetic coupling with the probe is changed and a defect signal can be read by measuring the coil impedance variation.

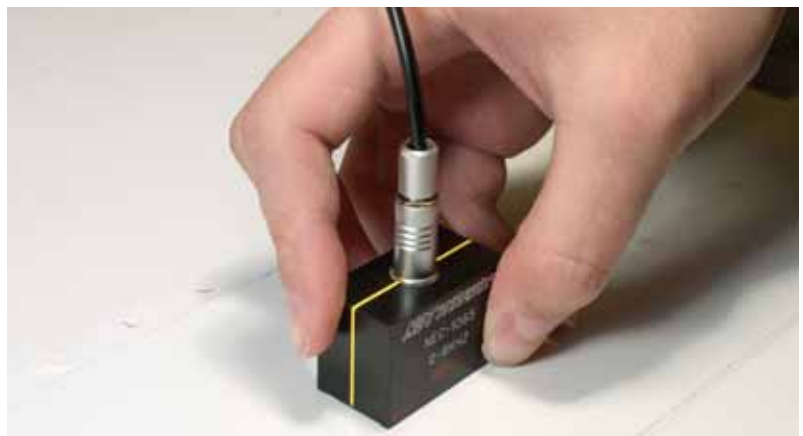

Surface preparation is minimal. Unlike liquid penetrant or magnetic particle inspection, it is unnecessary to remove the paint from the surface to inspect the parts.





# Eddy Current Software

## Impedance Plane and Strip Chart Display

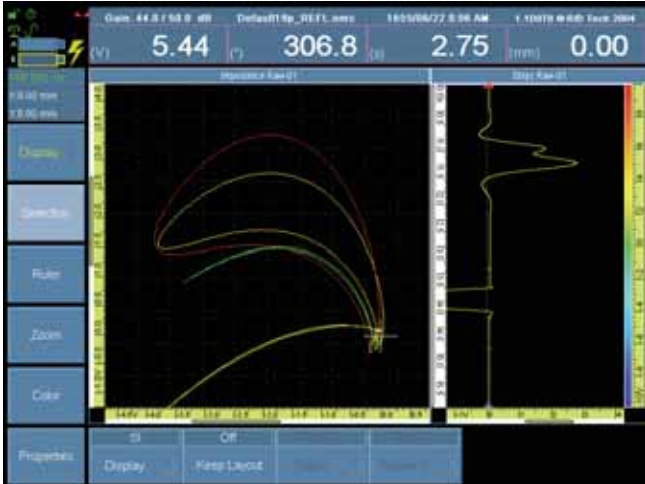

- User-selectable screen persistency
- Two-frequency operation and automatic mixing capability
- Reference signal overlay can be kept on the screen for easier signal interpretation.
- Freeze mode allows signal rotation and gain adjustment without having to hold the probe on the part.
- Zoom and Best Fit functions

## Conductivity and Thickness Measurement Mode



Conductivity and thickness measurement

- Simple step-by-step calibration procedure
- Material conductivity or coating thickness are displayed with very large numerals.
- Impedance plane display for signal representation during measurement
- Instruction window guides the operator during the measurement process.
- Adjustable threshold represents the measurement values in blue, green, or red.
- Measurements can be stored in a tabular report.

## Rotating Probe Operation

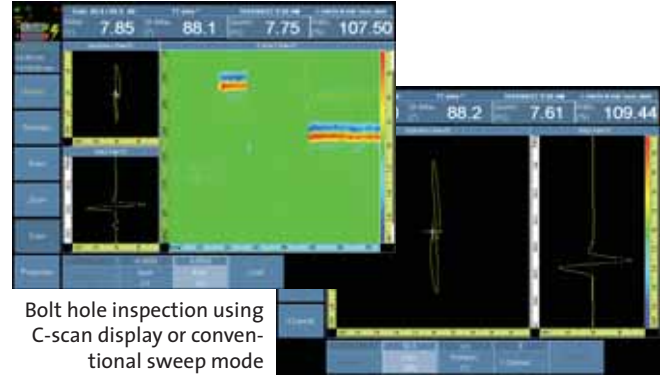

Bolt hole inspection using C-scan display or conventional sweep mode

- Impedance plane with synchronized sweep trace displayed simultaneously
- Adjustable impedance plane persistency to show one or several probe rotations on the screen
- Scrolling C-scan display to represent the inspected area in a 2-D color map
- High acquisition rate allows smooth signal representation and high-speed rotation.
- Real-time data interpolation or compression to compensate for rotation speed variation
- Full data recording capability
- Special median high-pass filter provides a stable trace.

## C-Scan Surface Mapping

- Support of two encoder inputs to connect various scanners
- Real-time C-scan mapping display with impedance plane and strip chart view

## Advanced Real-Time Data Processing

- Three alarms can be defined with various shapes to activate LED, buzzer, or TTL output.
- High-pass, low-pass, and specialized filters



Alarm zone in impedance plane on OmniScan ECT.

# Eddy Current Array Inspection

## Eddy Current Array Technology

Eddy current array (ECA) technology allows to electronically drive and read several eddy current sensors positioned side-by-side in the same probe assembly. Data acquisition is made possible through the use of multiplexing, which avoids mutual inductance between the individual sensors.

The OmniScan™ ECA test configuration supports 32 sensor coils (up to 64 with an external multiplexer) working in bridge or transmit-receive mode. The operating frequency ranges from 20 Hz to 6 MHz with the option of using multiple frequencies in the same acquisition.

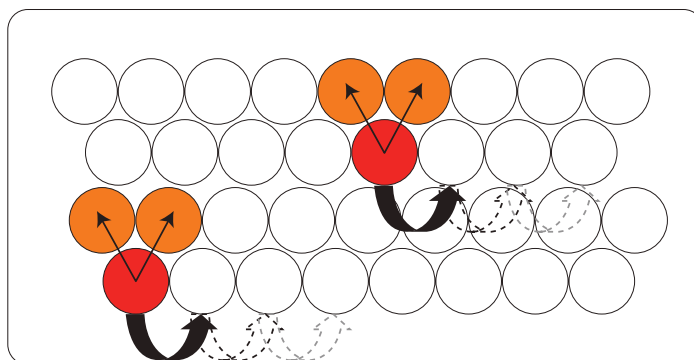

Multiplexing principle between elements.

## Benefits of Eddy Current Arrays

Compared to single-channel eddy current technology, eddy current array technology provides the following benefits:

- Drastically reduces inspection time.
- Covers a large area in one single pass.
- Reduces the complexity of mechanical and robotic scanning systems.
- Provides real-time cartography of the inspected region, facilitating data interpretation.
- Is well suited for complex part geometries.
- Improves reliability and probability of detection (POD).

Single coil = raster scan

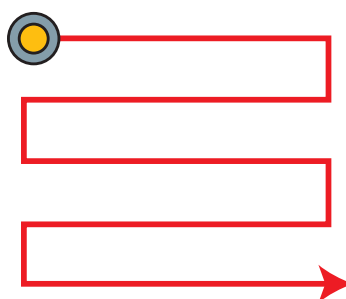

Multiple coils = one-line scan

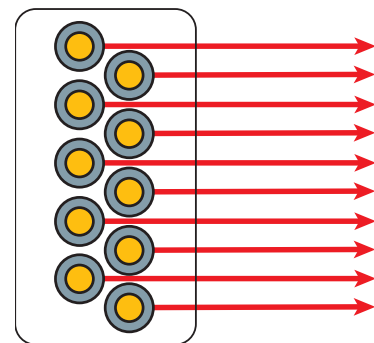

Eddy current array probes can replace one axis of a two-axis scan and offer greater flexibility in the eddy current setup.

## Eddy Current Array Probes

R/D Tech manufactures ECA probes for a wide range of applications. Probes can be designed to detect a specific type of flaw or to follow the shape of the part to inspect. Standard designs are available to detect defects such as cracks and pitting, and subsurface defects like cracks in multilayer structures as well as corrosion.

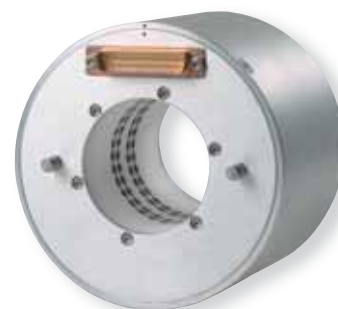

Probes can be made in different shapes and sizes to better follow the contour of the part to inspect.



Transmit-receive probe for corrosion detection down to 6 mm (0.125 in.) in aluminum.



Transmit-receive probe for surface crack detection shown with optional encoder.



Absolute probe for surface crack detection.

# Eddy Current Array Software

## Simple Acquisition and Analysis Displays

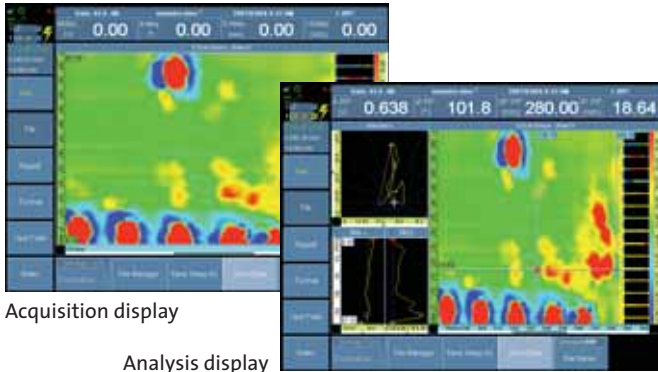

Acquisition display

Analysis display

- Data acquisition in a C-scan view for quick and efficient defect detection
- Data selection in analysis mode to review the signal in the impedance plane and strip charts
- Amplitude, phase, and position measurement
- Adjustable color palette
- Large impedance plane and strip chart views to accommodate conventional single-channel ECT probe inspection



Fastener inspection using two frequencies and dual C-scan display.

## Calibration Wizard

- Step-by-step process
- All the channels of a group are calibrated simultaneously, each channel having its own gain and rotation.
- Amplitude and phase can be set on different reference flaws.

## Alarms

- Three alarm outputs can combine LED, buzzer, and TTL output.
- Various alarm zone shapes can be defined in the impedance plane (sector, rectangular, ring, etc.).

## Automatic Probe Detection and Configuration

- C-scan parameters and multiplexing sequence are automatically set when the probe is connected.
- Frequency range protection to avoid probe damage

## Subtraction Tools in Analysis Mode

This function can be used to remove the lift-off variation that can be seen between adjacent channels.

## Advanced Real-Time Data Processing

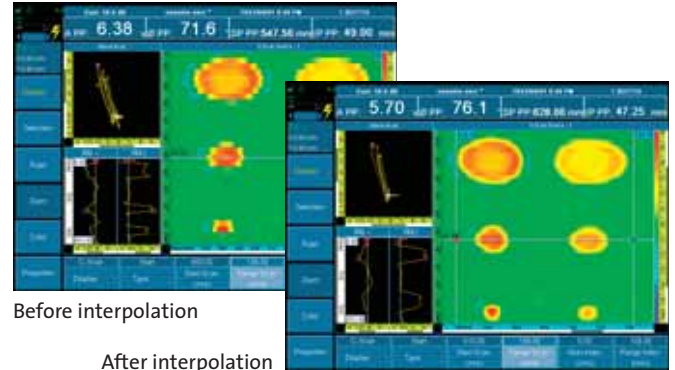

Before interpolation

After interpolation

- Real-time data interpolation to improve the spatial representation of the defects
- When working with two frequencies, a MIX signal can be generated to remove unwanted signals (like lift-off, fastener signals, etc.).

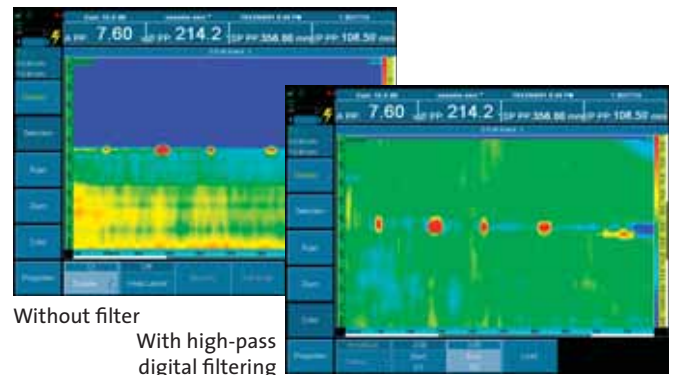

Without filter

With high-pass digital filtering

- Several filters can be applied to the data such as high-pass, low-pass, median, and averaging. The figures above represent an application where the cracks are located at the edge of a lap-joint, which has a sharp thickness variation. The filtered data may improve detection, especially for small cracks.

# Omniscan MX Specifications

Overall dimensions	321 mm x 209 mm x 125 mm (12.6 in. x 8.2 in. x 5 in.)
Weight	4.6 kg (10.1 lb) (including test module and one battery)

## Data storage

Storage devices	CompactFlash® card, most standard USB storage device, or through fast Ethernet™ Internal 32 MB DiskOnChip® 200 MB
-----------------	---

Data file size

## I/O ports

USB ports	3
Speaker out	Yes
Microphone input	Yes
Video output	Video out (SVGA)
Video input	Video input (NTSC/PAL)
Ethernet™	10/100 Mb/s

## I/O lines

Encoder	2-axis encoder line (quadrature or clock/direction)
Digital input	2 digital inputs TTL, 5 V
Digital output	4 digital outputs TTL, 5 V, 10 mA
Remote communication	Remote communication RS-232 or RS485
Acquisition on/off switch	Remote acquisition enable TTL, 5 V
Power output line	5 V, 500 mA power output line (short-circuit-protected)
Alarms	3 TTL, 5 V, 10 mA
Analog output	2 analog outputs (12 bits) ±5 V in 10 kΩ
Pace input	5 V TTL pace input

## Display

Display size	8.4 in. (diagonal)
Resolution	800 x 600 pixels
Number of colors	16 million
Type	TFT LCD

## Power supply

Battery type	Smart Li-ion battery
Number of batteries	1 or 2 (battery chamber accommodates two hot-swappable batteries)
Battery life	Minimum 6 hours with two batteries; minimum of 3 hours per battery in normal operation conditions
DC-in voltage	15 V – 18 V (min. 50 W)

## Environmental specifications

Operating temperature	0°C to 45°C
Storage temperature	-20°C to 70°C
Relative humidity	0–95% non condensing. No air intake, splashproof design.



# Ultrasound Module Specifications

Overall dimensions	244 mm x 182 mm x 57 mm (9.6 in. x 7.1 in. x 2.1 in.)
Weight	1 kg (2.2 lb)
Connectors	LEMO® 00 (2)

## Pulser/Receiver

Number of pulsers/receivers 2

### Pulser

Pulse output	50 V, 100 V, 200 V ±10% (variable pulse width)
Pulse width	Adjustable from 30 ns to 500 ns ±10%, resolution of 2.5 ns
Fall time	Less than 10 ns
Pulse shape	Negative square wave
Output impedance	Less than 4 Ω

### Receiver

Receiver gain range	0–100 dB, by steps of 0.1 dB
Maximum input signal	14 V p-p (screen at 128%)
Minimum sensibility	140 μV p-p (screen at 128%)
Noise referred to input	140 μV p-p (23 μV RMS) (128%)
Input impedance	50 Ω
Input filter (100% bandwidth)	Centered at 1 MHz (1.5 MHz), centered at 2 MHz (2.25 MHz), centered at 5 MHz (4 MHz), centered at 10 MHz (12 MHz), centered at 15 MHz, 0.25–2.5 MHz, 10–35 MHz ±10% HP, 2–25 MHz BB
Bandwidth of the system	0.25–35 MHz (–3 dB)
Rectifier	Both, positive, negative
Mode	P-P, P-R, T-T (through-transmission), maximum of 2 channels in P-P, maximum of 1 channel in P-R, (ex.: P1→P2)
Smoothing	Digital

## DAC

Number of points	16
DAC range	Up to 40 dB
Maximum gain slope	20 dB/μs

## Data acquisition

A-scan acquisition rate	6000 A-scans/s (512-point A-scan)
Maximum pulsing rate	1 channel at 10 kHz (C-scan)

## Data processing

Real-time averaging	2, 4, 8, 16
---------------------	-------------

## Gates

Quantity	3: I (synchro), A and B (measure)
Synchronization	I, A, B referenced on main bang, A and B referenced on gate I (post-synchronization)

## Data storage

A-scan recording (TOFD)	6000 A-scans/s (512-point A-scan) (3 MB/s transfer rate)
C-scan type data recording	20,000 (A1, A2, A3, T1, T2, T3) (3 gates) 10 kHz (lower frequency for corrosion mapping)

## Data visualization

Refresh rate	60 Hz
--------------	-------

## Data synchronization

On time	10 Hz–10 kHz
External	Yes
On encoder	On 1 or 2 axes divided into 1 to 65,536 steps

## Alarms

Number	3
Conditions	Any logical combination of gates
Signal	Amplitude or time of flight of gate A or B
Frequency	Up to 10 kHz

## Eddy Current Modules Specifications

	EC Array	Eddy Current
Overall dimensions	244 mm x 182 mm x 57 mm (9.6 in. x 7.1 in. x 2.1 in.)	
Weight	1.2 kg (2.6 lb)	
Connectors	1 OmniScan connector for eddy current array probes 1 19-pin Fischer® eddy current probe connector 1 BNC connector	N/A
Number of channels	32 channels with internal multiplexer 64 channels with external multiplexer	4 channels
Probe recognition	Automatic probe recognition and setup	

### Generator

Number of generators	1 (with internal electronic reference)
Maximum voltage	12 V p-p into 10 Ω
Operating frequency	20 Hz – 6 MHz
Bandwidth	8 Hz – 5 kHz (in single coil). Inversely proportional to the time slot duration and set by the instrument in multiplexed mode.

### Receiver

Number of receivers	1 to 4
Maximum input signal	1 V p-p
Gain	28–68 dB

### Internal multiplexer

Number of generators	32 (4 simultaneously on 8 time slots; up to 64 with external multiplexer)	N/A
Maximum voltage	12 V p-p into 50 Ω	
Number of receivers	4 differential receivers (8 time slots each)	
Maximum input signal	1 V p-p	

### Data acquisition

Digitizing frequency	40 MHz
Acquisition rate	1 Hz – 15 kHz (in single coil). The rate can be limited by the instrument's processing capabilities or by delays set by the multiplexed excitation mode.
A/D resolution	16 bits

### Data processing

Phase rotation	0° to 360° with increments of 0.1°
Filtering	FIR low-pass, FIR high-pass, FIR band-pass, FIR band-stop (adjustable cutoff frequency), median filter (variable from 2 to 200 points), mean filter (variable from 2 to 200 points)
Channel processing	Mixing Interpolation

### Data storage

Maximum file size	Limited by memory size
-------------------	------------------------

### Data synchronization

On internal clock	1 Hz – 15 kHz (single coil)
External pace	Yes
On encoder	On 1 or 2 axes

### Alarms

Number of alarms	3
Alarm zone shape	Pie, inverted pie, box, inverted box, and ring
Output type	Visual, audio, and TTL signals
Analog outputs	1 (X or Y)

## Phased Array Module Specifications

Overall dimensions	244 mm x 182 mm x 57 mm (9.6 in. x 7.1 in. x 2.1 in.)
Weight	1.2 kg (2.6 lb)
Connectors	1 OmniScan connector for phased-array probes 2 BNC connectors (1 pulser/receiver, 1 receiver for conventional UT)
Number of focal laws	256
Probe recognition	Automatic probe recognition and setup

### Pulser/Receiver

Aperture	16 elements
Number of elements	128 elements

### Pulser

Voltage	80 V per element
Pulse width	Adjustable from 30 ns to 500 ns, resolution of 2.5 ns
Fall time	Less than 10 ns
Pulse shape	Negative square wave
Output impedance	Less than 25 Ω

### Receiver

Gain	0–74 dB maximum input signal 1.32 V p-p 75 Ω
Input impedance	75 Ω
System bandwidth	0.75–18 MHz (–3 dB)

### Beam forming

Scan type	Azimuthal and linear
Active elements	16
Elements	128
Delay range transmission	0–10 μs in 2.5-ns increments
Delay range reception	0–10 μs in 2.5-ns increments

### Data acquisition

Digitizing frequency	100 MHz (10 bits)
Maximum pulsing rate	Up to 20 kHz (C-scan)
Acquisition depth	59.8 meters in steel (L-wave), 10 ms with compression. 0.49 meter in steel (L-wave), 81.9 μs without compression

### Data processing

Number of data points	Up to 8000
Real-time averaging	2, 4, 8, 16
Rectifier	RF, full wave, halfwave +, halfwave –
Filtering	Low-pass (adjusted to probe frequency), digital filtering (bandwidth, frequency range)
Video filtering	Smoothing (adjusted to probe frequency range)

### Data storage

A-scan recording (TOFD)	5000 A-scans per second (512-point 8-bit A-scan)
C-scan type data recording	I, A, B, up to 20 kHz (amplitude or TOF)
Maximum file size	Limited by memory size

### Data visualization

A-scan refresh rate	Real-time: 60 Hz
Volume-corrected S-scan	Up to 40 Hz

### Data synchronization

On internal clock	1 Hz – 20 kHz
External pace	Yes
On encoder	On 1 or 2 axes

### Programmable time-corrected gain (TCG)

Number of points	16 (1 TCG curve per channel for focal laws)
------------------	---

### Alarms

Number of alarms	3
Conditions	Any logical combination of gates
Analog outputs	2

